

MyFAST® 12.0 BASIC

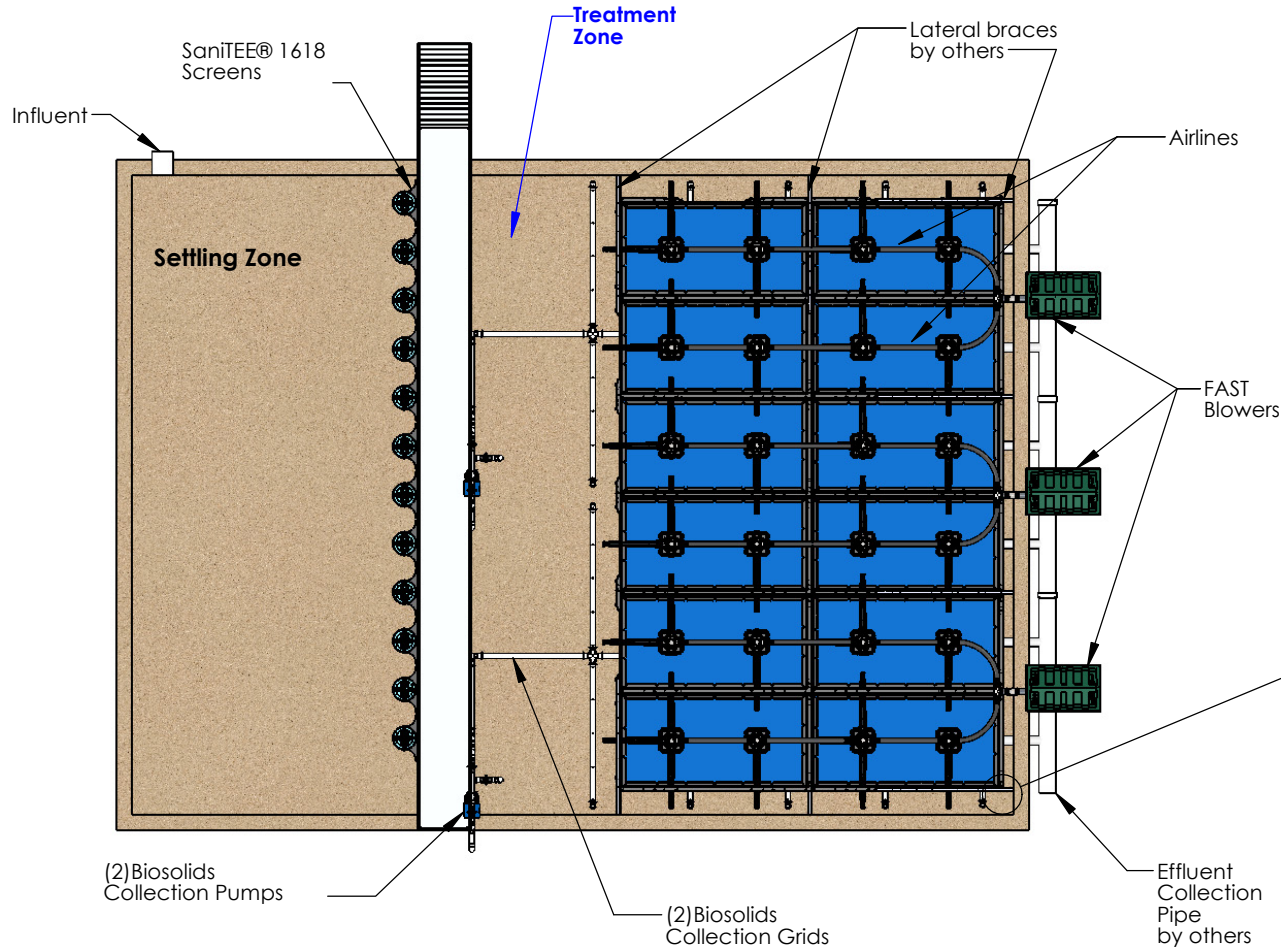

**Product Description & Layout
MyFAST® 12.0 BASIC**

Designed to treat approximately 120,000GPD (454 m3/day) of residential waste water. For non-residential or mixed use applications, contact factory for guidance.

- (12) MyFAST® Liners
- (12) SaniTEE® 1618 Screens
- Blowers & Blower housings
- Control Panel
- Air Distribution Assembly
- (2) Biosolids Collection Grids
- (2) Biosolids Collection Pumps
- valves and manifolds
- (8) Lateral braces

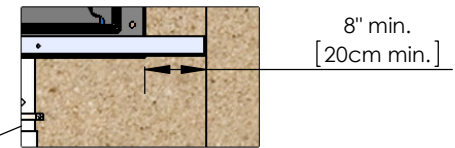

DETAIL A

DO NOT SCALE
UNLESS NOTED
DIMENSIONS
ARE IN INCHES
[CENTIMETERS]
TOLERANCES
± 0.02 IN/IN
[± 0.05 CM/CM]



MyFAST 12.0

WEIGHT		lb	SIZE	DRAWING NUMBER		SHEET 1 OF 9
NAME	DATE		A	Basic Layout		
DRAWN	CTC	3/27/2009		REVISED 9/19/2013		
CHECKED	PF	9/19/2013		REV. INI-10-V		

THE INFORMATION CONTAINED IN THIS DRAWING IS THE SOLE PROPERTY OF BIO-MICROBICS INC. ANY REPRODUCTION IN PART OR AS A WHOLE WITHOUT THE WRITTEN PERMISSION OF BIO-MICROBICS INC. IS PROHIBITED. DESIGN AND INVENTION RIGHTS ARE RESERVED. IN THE INTEREST OF TECHNOLOGICAL ADVANCEMENT, ALL PRODUCTS ARE SUBJECT TO DESIGN AND OR MATERIAL CHANGE WITHOUT NOTICE.

BIO-MICROBICS © 2014

**MyFAST® 12.0 OPTIONAL:
MyTEE®Screen, AMS & BMS**

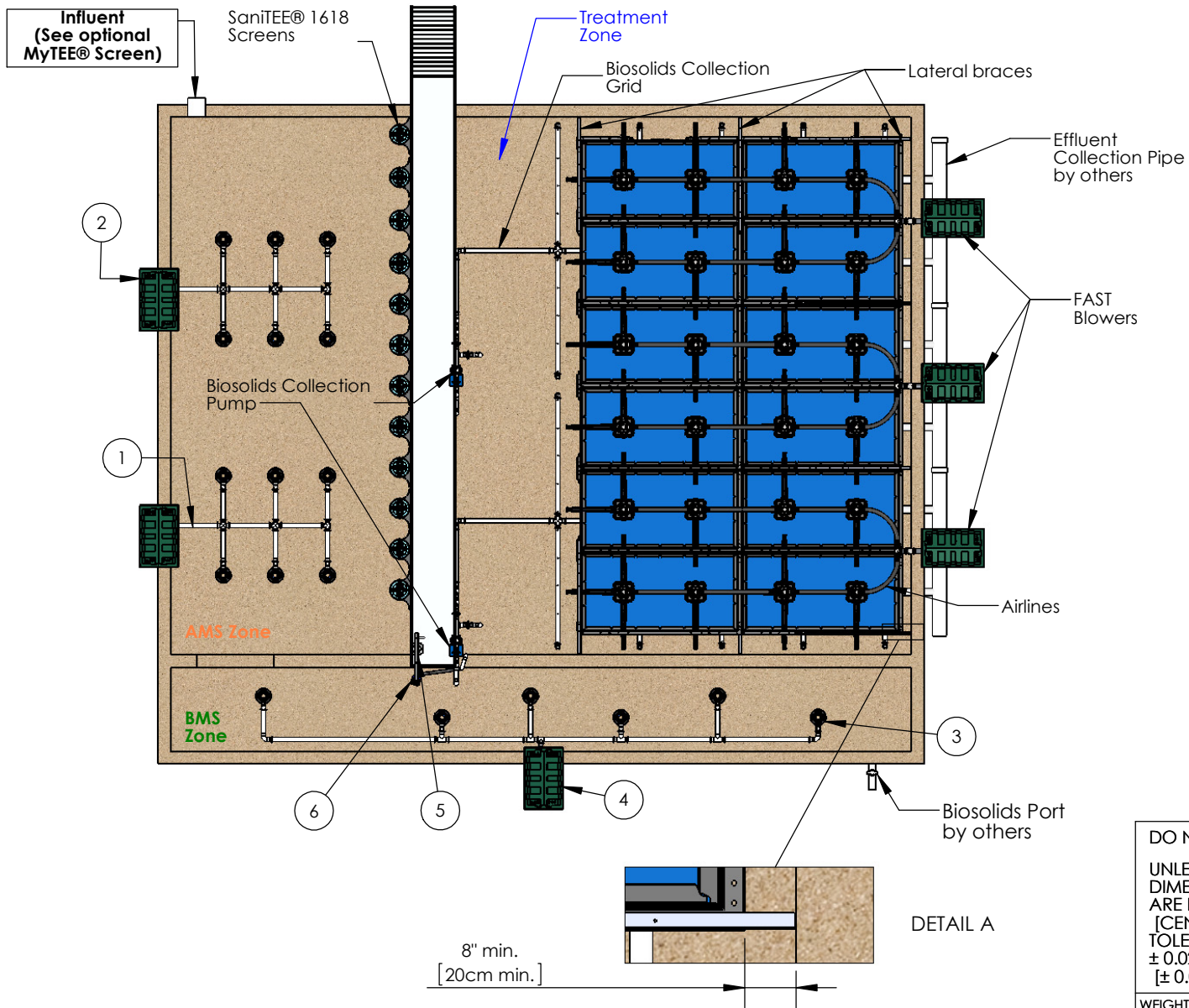

**Product Description & Layout
MyFAST® 12.0 BASIC**

Designed to treat approximately 120,000GPD (454 m3/day) of residential waste water. For non-residential or mixed use applications, contact factory for guidance.

- (12) MyFAST® Liners
- (12) SaniTee® 1618 Screens
- Blowers & Blower housings
- Control Panel
- Air Distribution Assembly
- (2) Biosolids Collection Grids
- (2) Biosolids Collection Pumps valves and manifolds
- (8) Lateral braces

OPTIONS

Aeration Management System (AMS)

LIXOR® aeration system provides oxygen and mixing, reducing primary sludge.

1. (2) LIXOR® 6.0 XD
2. Blowers & Blower Housings
- Control Panel

Biosolids Management System (BMS)

LIXOR® aeration system to reduce Biosolids Quantity.

3. LIXOR® 6.0
4. Blower & Blower Housing
5. Jib Crane
6. Decant Pump
- Control Panel

MyTEE™Screen

A prescreening device is required prior to AMS Zone. MyTEE™ screen provides separation of non-biological solids and grit.
See sheet 5 of 8 MyTEE® Screen

DO NOT SCALE
UNLESS NOTED
DIMENSIONS
ARE IN INCHES
[CENTIMETERS]
TOLERANCES
± 0.02 IN/IN
[± 0.05 CM/CM]



MyFAST 12.0

WEIGHT		lb	SIZE	DRAWING NUMBER		SHEET 2 OF 9
NAME	DATE		A	Options Layout		
DRAWN	CTC	3/27/2009				
CHECKED	PF	9/19/2013		REVISED 9/19/2013	REV. INI-10-V	

THE INFORMATION CONTAINED IN THIS DRAWING IS THE SOLE PROPERTY OF BIO-MICROBICS INC. ANY REPRODUCTION IN PART OR AS A WHOLE WITHOUT THE WRITTEN PERMISSION OF BIO-MICROBICS INC. IS PROHIBITED. DESIGN AND INVENTION RIGHTS ARE RESERVED. IN THE INTEREST OF TECHNOLOGICAL ADVANCEMENT, ALL PRODUCTS ARE SUBJECT TO DESIGN AND OR MATERIAL CHANGE WITHOUT NOTICE.

BIO-MICROBICS © 2014

MyFAST® 12.0 Tank Details

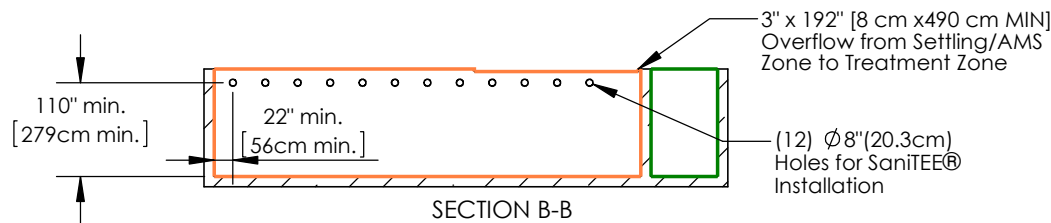
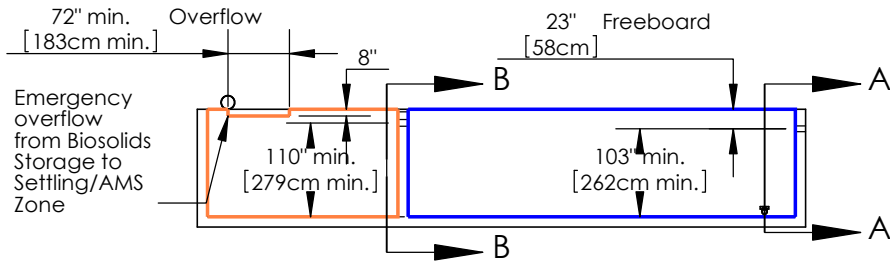
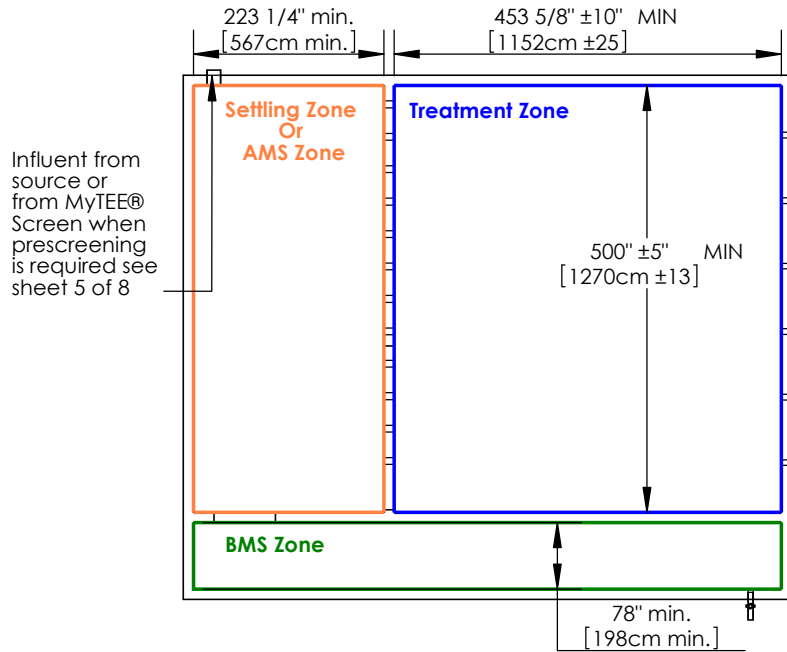

Lid Access Requirements

detailed drawings available upon request

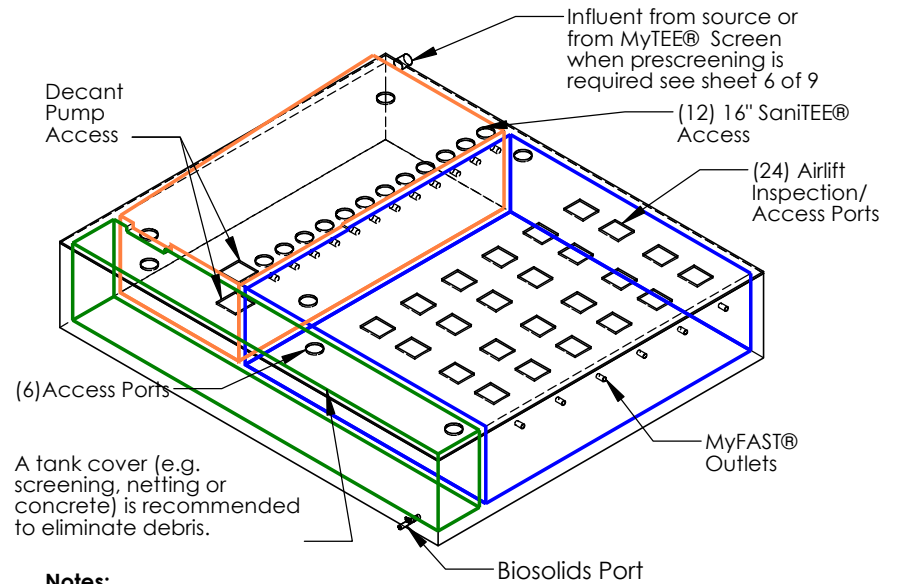

Notes:
When tank is covered adequate ventilation will be required, refer to the BASIC, AMS, & Specification sheets for additional details.

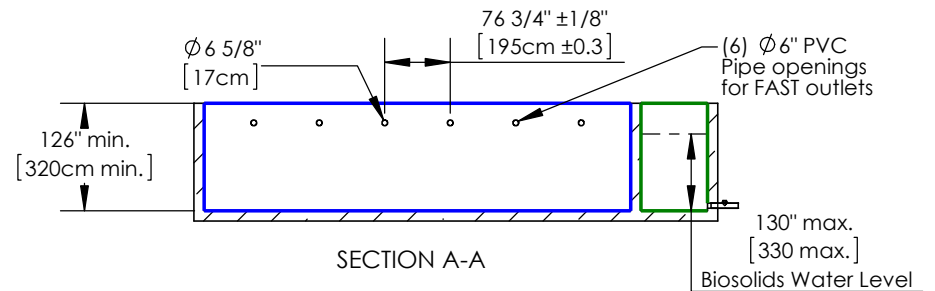

DO NOT SCALE
UNLESS NOTED DIMENSIONS ARE IN INCHES [CENTIMETERS] TOLERANCES ± 0.02 IN/IN [± 0.05 CM/CM]



MyFAST 12.0

WEIGHT	lb	SIZE	DRAWING NUMBER	SHEET 3 OF 9
NAME	DATE	A	Tank Details	
DRAWN	CTC 3/27/2009			
CHECKED	PF 9/19/2013	REVISED 9/19/2013	REV. INI-05-X	

THE INFORMATION CONTAINED IN THIS DRAWING IS THE SOLE PROPERTY OF BIO-MICROBICS INC. ANY REPRODUCTION IN PART OR AS A WHOLE WITHOUT THE WRITTEN PERMISSION OF BIO-MICROBICS INC. IS PROHIBITED. DESIGN AND INVENTION RIGHTS ARE RESERVED. IN THE INTEREST OF TECHNOLOGICAL ADVANCEMENT, ALL PRODUCTS ARE SUBJECT TO DESIGN AND OR MATERIAL CHANGE WITHOUT NOTICE.

BIO-MICROBICS © 2014

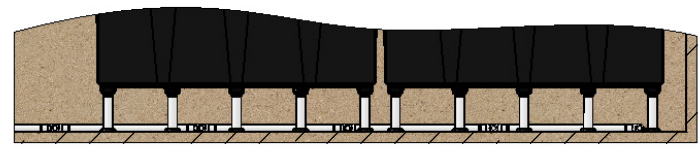
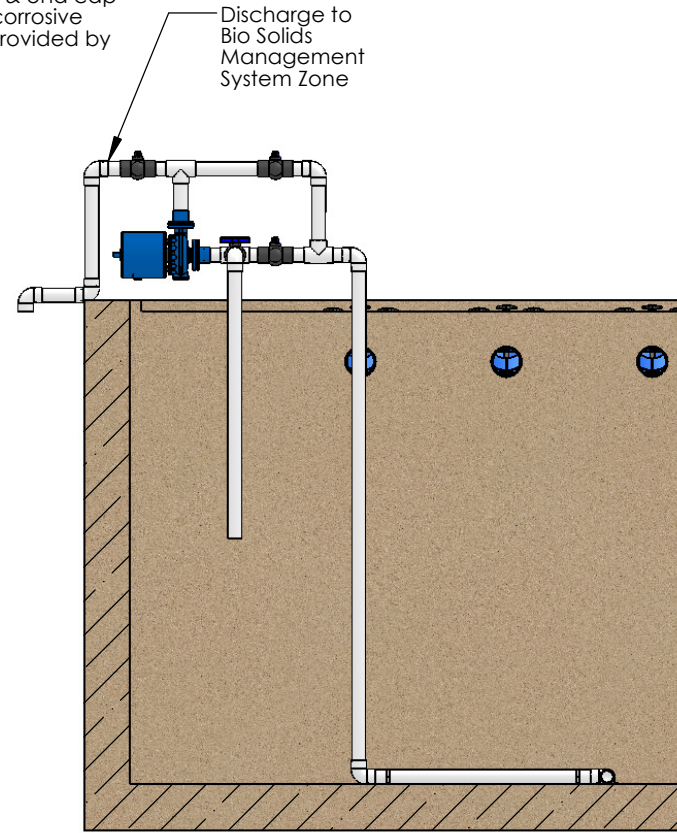
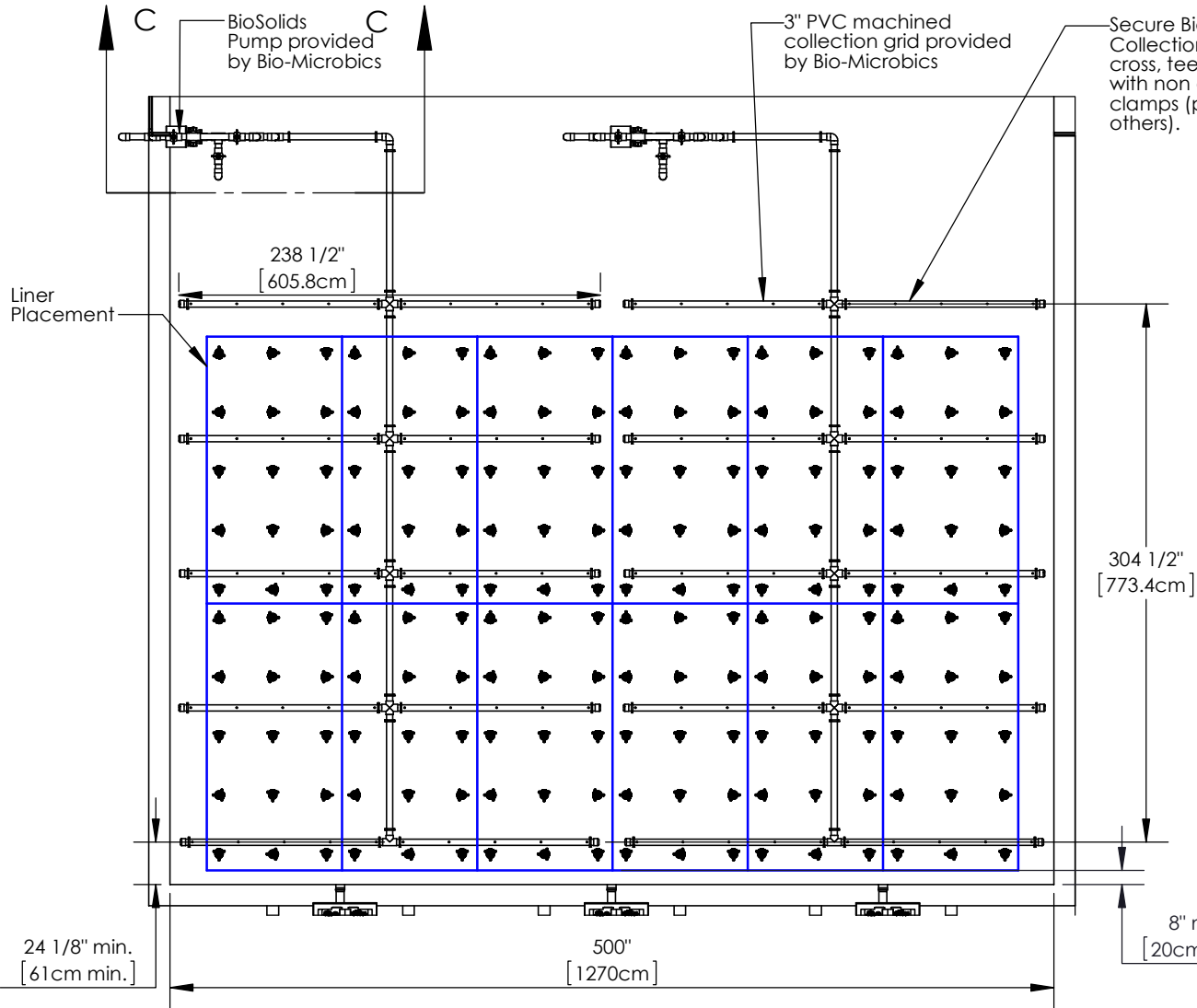

DO NOT SCALE
UNLESS NOTED DIMENSIONS ARE IN INCHES [CENTIMETERS] TOLERANCES ± 0.02 IN/IN [± 0.05 CM/CM]



MyFAST 12.0

THE INFORMATION CONTAINED IN THIS DRAWING IS THE SOLE PROPERTY OF BIO-MICROBICS INC. ANY REPRODUCTION IN PART OR AS A WHOLE WITHOUT THE WRITTEN PERMISSION OF BIO-MICROBICS INC. IS PROHIBITED. DESIGN AND INVENTION RIGHTS ARE RESERVED. IN THE INTEREST OF TECHNOLOGICAL ADVANCEMENT, ALL PRODUCTS ARE SUBJECT TO DESIGN AND OR MATERIAL CHANGE WITHOUT NOTICE.

BIO-MICROBICS © 2014

WEIGHT	lb	SIZE	DRAWING NUMBER	SHEET 4 OF 9
NAME	DATE	A	Biosolids Collection System	
DRAWN	CTC 3/27/2009			
CHECKED	PF 9/19/2013	REVISED	9/19/2013	
		REV.	INI-10-V	

Biosolids Management System (BMS) Option

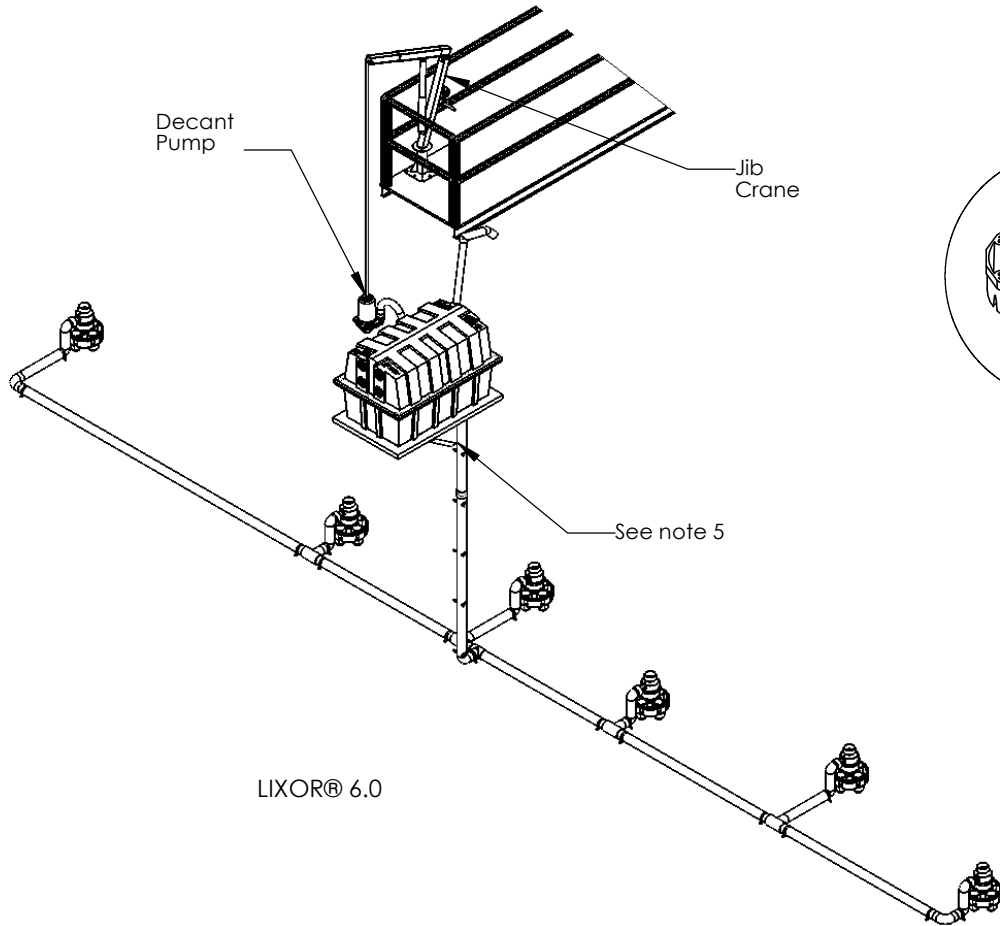

Aeration Management System (AMS) Option

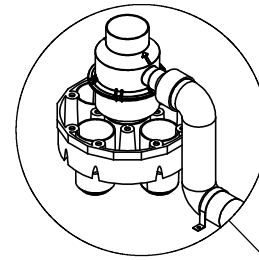

LIXOR DETAIL

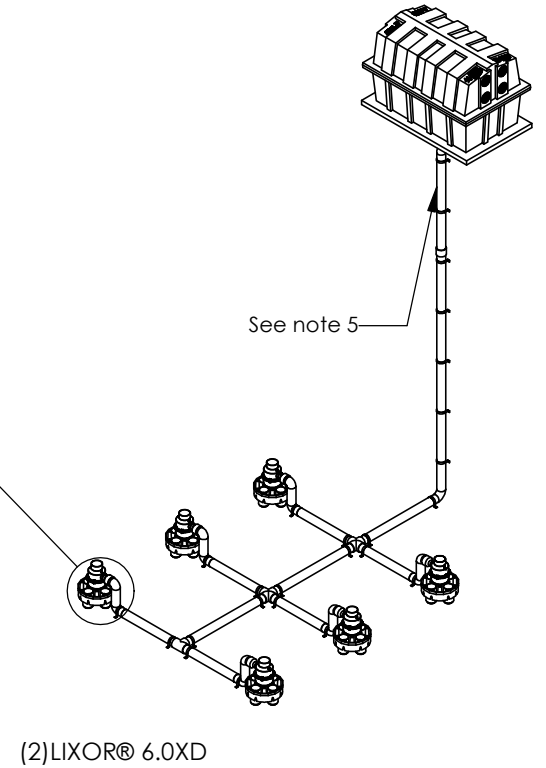

NOTES

1. Blower piping to LIXOR® may not exceed 100 FT [30.5m] in total length and use a maximum of 6 elbows, to get to the tank. For distances greater than 100 FT [30.5m] - consult factory. Blower must be located above flood/standing water levels on a concrete base 36" X 58" X 2" [91X147X5cm] minimum.
2. The air supply line must be secured with a non-corrosive clamp every 2' [0.6m] minimum to prevent vibration induced damage.
3. Refer to sheet 8 of 9 & 9 of 9 for additional details.
4. Installation of the LIXOR® shall be done in accordance with the written instructions provided by the manufacturer. Refer to LIXOR® Installation Manual for more details.

DO NOT SCALE
UNLESS NOTED
DIMENSIONS
ARE IN INCHES
[CENTIMETERS]
TOLERANCES
± 0.02 IN/IN
[± 0.05 CM/CM]



MyFAST 12.0

THE INFORMATION CONTAINED IN THIS DRAWING IS THE SOLE PROPERTY OF BIO-MICROBICS INC. ANY REPRODUCTION IN PART OR AS A WHOLE WITHOUT THE WRITTEN PERMISSION OF BIO-MICROBICS INC. IS PROHIBITED. DESIGN AND INVENTION RIGHTS ARE RESERVED. IN THE INTEREST OF TECHNOLOGICAL ADVANCEMENT, ALL PRODUCTS ARE SUBJECT TO DESIGN AND OR MATERIAL CHANGE WITHOUT NOTICE.

BIO-MICROBICS © 2014

WEIGHT	lb	SIZE	DRAWING NUMBER		SHEET 5 OF 9
NAME	DATE	A	Options		
DRAWN	CTC 3/27/2009		REVISED 9/19/2013		
CHECKED	PF 9/19/2013		REV. INI-10-V		

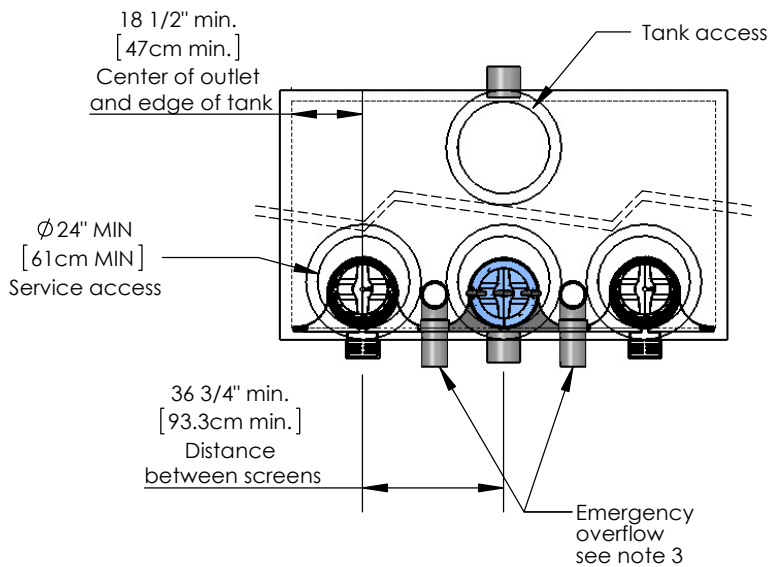
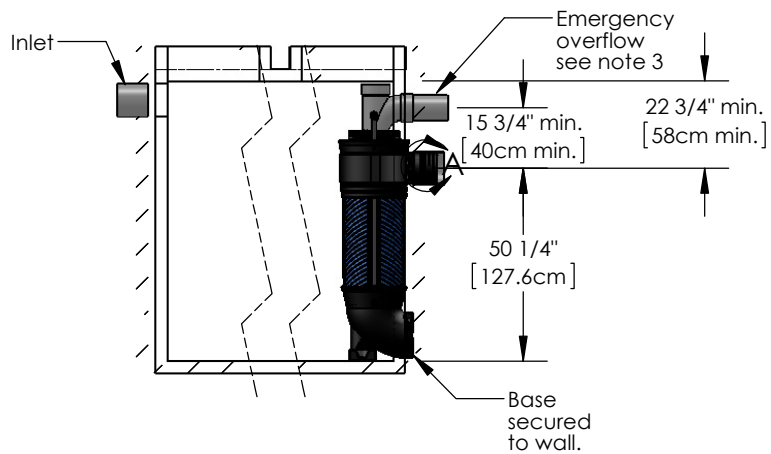

3rd
SaniTEE
not Shown

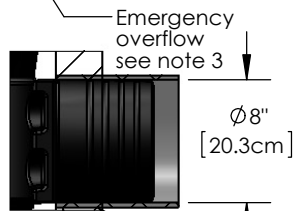
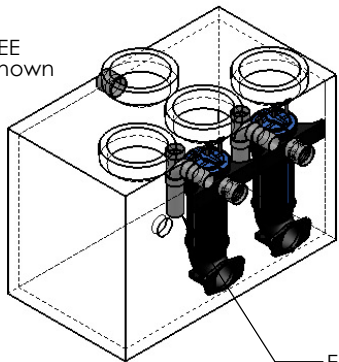

If installed as shown in a single compartment tank the 8" PVC pipe must be water tight within the tank and flush against the inside to mount 16" MyTEE bottom diverter

DETAIL A

Outlet optional 8" PVC pipe provided by others to connect outlet to secondary tank

NOTES:

1. MyTEE® screens provide separation of non-biological solids and grit.
2. Each 1638 MyTEE® unit should be placed under a 24" [61 cm] Ø riser for proper operation of the internal and external swabs.
3. Tank inlet flow line must be at least 2" above the emergency overflow outlet flow line. Emergency overflow must be sized to handle the designed peak flow event.
4. See table for required MyTEE® quantities and maximum tank volume.
5. Outlet pipe not included.
6. All appurtenances to MyTEE® (e.g. septic tank, access risers, etc) must conform to all applicable codes.
7. See additional details in MyFAST® Installation Manual.

MyTEE® 1638 Screen		
Flow	Maximum Tank Volumes	MyTEE® Quantity
20 000 GPD [76 m3/Day]	(1) 2500 gallon [10m3] tank	2
40 000 GPD [150 m3/Day]	(1) 5000 gallon [19m3] tank	2
60 000 GPD [230 m3/Day]	(1) 7500 gallon [28m3] tank	3
80 000 GPD [300 m3/Day]	(1) 10000 gallon [38m3] tank	4
120 000 GPD [454 m3/Day]	(1) 15000 gallon [55m3] tank	6
160 000 GPD [600 m3/Day]	(1) 20000 gallon [75m3] tank	8

DO NOT SCALE
UNLESS NOTED
DIMENSIONS
ARE IN INCHES
[CENTIMETERS]
TOLERANCES
± 0.02 IN/IN
[± 0.05 CM/CM]



MyFAST 12.0

THE INFORMATION CONTAINED IN THIS DRAWING IS THE SOLE PROPERTY OF BIO-MICROBICS INC. ANY REPRODUCTION IN PART OR AS A WHOLE WITHOUT THE WRITTEN PERMISSION OF BIO-MICROBICS INC. IS PROHIBITED. DESIGN AND INVENTION RIGHTS ARE RESERVED. IN THE INTEREST OF TECHNOLOGICAL ADVANCEMENT, ALL PRODUCTS ARE SUBJECT TO DESIGN AND OR MATERIAL CHANGE WITHOUT NOTICE.

BIO-MICROBICS © 2014

WEIGHT	lb	SIZE	DRAWING NUMBER		SHEET 6 OF 9
NAME	DATE	A	MyTEE®		
DRAWN	CTC 3/27/2009				
CHECKED	PF 9/19/2013		REVISED 9/19/2013	REV. INI-01-Q	

Specifications for MyFAST® 12.0 BASIC Wastewater Treatment System

1. GENERAL

The MyFAST® 12.0 treatment system is designed to treat approximately 120,000 gpd (454 m3/day) of residential strength wastewater. For non-residential or mixed use applications, consult factory for guidance. The principal items of equipment shall include twelve (12) FAST® interconnecting liners with leg attachments, airlifts, hoses, two (2) biosolids collection manifolds, two (2) sludge pumps, twelve (12) SaniTEE® screens, (3) blower assemblies, and control panel. The MyFAST® 12.0 treatment unit shall be situated within a 120,000 gallon (454 m3) minimum tank, as shown on the plans. Settling tank(s)/AMS Zone equaling ½ to 1x daily flow must be used prior to MyFAST®. Tank(s) provided must conform to local, state, and all other applicable codes. The tank is to be supplied by others according to Bio-Microbics dimensions.

2. BLOWER

The blower shall be capable of delivering 1200 to 2100 CFM [2040 - 3570 m3/hr]. The blower assembly shall include an inlet filter with metal filter element. The blower shall be mounted outside the tank adjacent to the AMS Zone on a contractor supplied concrete base. The blower elevation must be higher than the water level in the tank and above any normal flood level. A two-piece, blower housing shall be provided with tamper-proof screws. Blower piping to the tank shall use non-corrosive material (Galvanized or Stainless Steel). Do not run galvanized steel inside the treatment tank. The 4 inch NPT steel discharge air line MyFAST® 4 inch NPT air header, and connections shall be provided and installed by others.

3. VENTILATION

Vent to desired location and cover opening with a vent grate with at least 340 sq in [2200 sq. cm] open surface area. Secure with Stainless Steel screws. Vent piping must not allow condensate build up or create back pressure. Vent must be above finished grade or higher.

4. ELECTRICAL/CENTRAL CONTROL PANEL

All wiring must conform to code and provide the specified power to the blower. Input power on 60Hz electrical system is 208-230/460 VAC, three phase, 189/104.4 FLA. Input power on 50Hz electrical systems 230/400 VAC, three phase 180/104.4 FLA. All conduit and wiring required on the project shall be supplied by others. The standard control panel shall utilize motor starters and overloads to be housed in a NEMA 4 X enclosure. The control panel shall consist of a visual and audible alarm to indicate loss of power to the blower. A manual silence switch is included.

5. BIOSOLIDS COLLECTION MANIFOLDS & GRIDS

Two biosolids collection systems will be located underneath the MyFAST® 12.0 liners. The collection assemblies consisting of; two collection grids, (trunk line, five lateral lines with engineered orifices), two biosolids manifolds, and two biosolids pumps. The contractor shall supply piping to connect the grid to the biosolids pump and to construct the manifold. A field adjustable event timer will control the duration and frequency of the biosolids wasting from the Treatment Zone. The biosolids collection system is reversible to facilitate back flush operations.

6. MEDIA

The MyFAST® media shall be manufactured of rigid PVC, polyethylene, or polypropylene and it shall be supported by the polyethylene insert. The media shall be fixed in position and contain no moving or wearing parts and shall not corrode. The media shall be designed and installed to ensure that sloughed solids descend through the media to the bottom of the tank.

7. FLOW & PIPE SIZING

The MyFAST 12.0 has six (6) six (6) inch gasketed effluent connections. Each effluent connection has a maximum unrestricted flow of 250 US GPM (9945 LPM) with a 2.0 design safety factor. MyFAST® systems have been successfully designed and tested receiving gravity and demand-based influent flow. When influent flow is controlled by pump or other means to help with highly variable flow conditions, then multiple dosing events should be used to maximize performance. For residential strength waste the flow rate shall not exceed 420 gpm (1590 Lpm) and a maximum hourly flow not to exceed 10% of the design daily flow. For non-residential or mixed use applications, consult the factory for guidance.

8. WARRANTY

Bio-Microbics, Inc. warrants all new MyFAST® models (MyFAST® 2.0, 4.0, 6.0, 8.0, 12.0, and 16.0) against defects in materials and workmanship for a period of one year after installation or eighteen (18 months) from the date of shipment whichever occurs first, subject to the following terms and conditions:

During the warranty period, if any part is defective or fails to perform as specified when operating at design conditions, and if the equipment has been installed and is being operated and maintained in accordance with the written instructions provided by Bio-Microbics, Inc., Bio-Microbics, Inc. will repair or replace at its discretion such defective parts free of charge. Defective parts must be returned by owner to Bio-Microbics, Inc.'s factory postage paid, if so requested. The cost of labor and all other expenses resulting from replacement of the defective parts and from installation of parts furnished under this warranty and regular maintenance items such as filters or bulbs shall be borne by the owner. This warranty does not cover general system misuse, aerator components which have been damaged by flooding or any components that have been disassembled by unauthorized persons, improperly installed or damaged due to altered or improper wiring or overload protection. This warranty applies only to the treatment plant and does not include any of the structure wiring, plumbing, drainage, septic tank or disposal system.

Bio-Microbics, Inc. reserves the right to revise, change or modify the construction and/or design of the MyFAST system, or any component part or parts thereof, without incurring any obligation to make such changes or modifications in present equipment. Bio-Microbics, Inc. is not responsible for consequential or incidental damages of any nature resulting from such things as, but not limited to, defect in design, material, or workmanship, or delays in delivery, replacements or repairs.

THIS WARRANTY IS IN LIEU OF ALL OTHER WARRANTIES EXPRESS OR IMPLIED. BIO-MICROBICS SPECIFICALLY DISCLAIMS ANY IMPLIED WARRANTY OF MERCHANTABILITY OR FITNESS FOR A PARTICULAR PURPOSE. NO REPRESENTATIVE OR PERSON IS AUTHORIZED TO GIVE ANY OTHER WARRANTY OR TO ASSUME FOR BIO-MICROBICS, INC., ANY OTHER LIABILITY IN CONNECTION WITH THE SALE OF ITS PRODUCTS. Contact your local distributor for parts and service.

DO NOT SCALE UNLESS NOTED DIMENSIONS ARE IN INCHES [CENTIMETERS] TOLERANCES ± 0.02 IN/IN [± 0.05 CM/CM]		 MyFAST 12.0	
WEIGHT	lb	SIZE	DRAWING NUMBER
		A	BASIC Specifications
DRAWN	3/27/2009	CHECKED	REV.
	9/19/2013	REVISED	9/19/2013

THE INFORMATION CONTAINED IN THIS DRAWING IS THE SOLE PROPERTY OF BIO-MICROBICS INC. ANY REPRODUCTION IN PART OR AS A WHOLE WITHOUT THE WRITTEN PERMISSION OF BIO-MICROBICS INC. IS PROHIBITED. DESIGN AND INVENTION RIGHTS ARE RESERVED. IN THE INTEREST OF TECHNOLOGICAL ADVANCEMENT, ALL PRODUCTS ARE SUBJECT TO DESIGN AND OR MATERIAL CHANGE WITHOUT NOTICE.

BIO-MICROBICS © 2014

SHEET 7 OF 9

AERATION MANAGEMENT SYSTEM (AMS) OPTION

1. GENERAL INSTALLATION INSTRUCTIONS

All work must be done in accordance with local codes and regulations. Installation of the Aeration Management System (AMS) Option shall be done in accordance with the written instructions provided by the manufacturer. A manual which includes descriptions of system installation, operation, and maintenance procedures shall be furnished. For further details refer to the Installation Manual.

3. (2)LIXOR® 6.0XD

The (2) LIXOR® 6.0XD system shall provide mixing to reduce primary sludge settling prior to the Treatment Zone. The contractor shall furnish and install (2) LIXOR® 6.0XD aeration systems in the AMS Zone of the MyFAST®. The system shall be complete with all needed equipment as shown on the drawings and specified herein. The principal items of equipment shall include LIXOR® aerator, blower assembly, blower controls and alarms. All other items will be provided by others. The (2) LIXOR® 6.0XD systems shall be evenly spaced within the AMS Zone as shown in the plans so as to maximize mixing and reduce settling. The AMS Zone Tank(s) must provide adequate access for service activities and comply with all state and local codes.

- **LIXOR® AERATOR**
The LIXOR® aerator shall be manufactured of rigid PVC and ABS. The aerator shall be fixed in position anchored by non corrosive fasteners supplied by others and contain no moving or wearing parts and shall not corrode.
- **BLOWER**
The LIXOR® 6.0XD system shall come equipped with two regenerative type blower capable of delivering 220-320 CFM [370-545 m3/hr]. The blower assembly shall include an inlet filter with metal filter element. The blower shall be secured on the walkway or perimeter, of tank on a contractor supplied base. The blower must not set in standing water and its elevation must be higher than the normal flood level and higher than the tanks operating level and higher than the tanks operating level. A two-piece, blower housing shall be provided. The discharge air line from the blower to the LIXOR® unit shall be provided and installed by others.
- **ELECTRICAL**
The electrical source should be within 150 feet [45.7 meters] of the blower. Consult local codes for longer wiring distances. All wiring must conform to all applicable codes (IEC, NEC, etc.). Wiring distances must prevent significant voltage loss. Input power on 60Hz electrical system is 3Ø 208-230/460 VAC, and 38.8/22.4 FLA total. Input power on 50Hz electrical system is 3Ø, 230/400 VAC, and 40/19 FLA total. All conduit and wiring shall be supplied by others.
- **CONTROLS**
The standard control panel provides power to the blower with an alarm system consisting of a visual and audible alarm capable of signaling blower circuit failure. A manual silence button is included.
- **VENTILATION**
If the AMS Zone is covered vent to the desired location and cover opening with a vent grate with at least 26 sq in. [160 sq. cm] open surface area. Secure with Stainless Steel screws. Vent piping must not allow condensate build up or create back pressure. Vent must be above finished grade or higher.

4.WARRANTY

Bio-Microbics, Inc. warrants all Bio-Microbics supplied AMS components against defects in materials and workmanship for a period of one year after installation or eighteen months from date of shipment which ever occurs first, subject to the following terms and conditions:
During the warranty period, if any part is defective or fails to perform as specified when operating at design conditions, and if the equipment has been installed and is being operated and maintained in accordance with the written instructions provided by Bio-Microbics, Inc. Bio-Microbics, Inc. will repair or replace at its discretion such defective parts free of charge. Defective parts must be returned by owner to Bio-Microbics, Inc.'s factory postage paid, if so requested. The cost of labor and all other expenses resulting from replacement of the defective parts and from installation of parts furnished under this warranty and regular maintenance items such as filters or bulbs shall be borne by the owner. This warranty does not cover: general system misuse, aerator components which have been damaged by flooding or any components that have been disassembled by unauthorized persons, improperly installed or damaged due to altered or improper wiring or overload protection. This warranty applies only to the AMS components and does not include any of the structure wiring, plumbing, drainage, septic tank or disposal system. Bio-Microbics, Inc. reserves the right to revise, change or modify the construction and/or design of the components, without incurring any obligation to make such changes or modifications in present equipment. Bio-Microbics, Inc. is not responsible for consequential or incidental damages of any nature resulting from such things as, but not limited to, defect in design, material, or workmanship, or delays in delivery, replacements or repairs.
THIS WARRANTY IS IN LIEU OF ALL OTHER WARRANTIES EXPRESS OR IMPLIED. BIO-MICROBICS SPECIFICALLY DISCLAIMS ANY IMPLIED WARRANTY OF MERCHANTABILITY OR FITNESS FOR A PARTICULAR PURPOSE.
NO REPRESENTATIVE OR PERSON IS AUTHORIZED TO GIVE ANY OTHER WARRANTY OR TO ASSUME FOR BIO-MICROBICS, INC., ANY OTHER LIABILITY IN CONNECTION WITH THE SALE OF ITS PRODUCTS.
Contact your local distributor for parts and service.

DO NOT SCALE		 MyFAST 12.0	
UNLESS NOTED DIMENSIONS ARE IN INCHES [CENTIMETERS] TOLERANCES ± 0.02 IN/IN [± 0.05 CM/CM]			
WEIGHT	lb	SIZE	DRAWING NUMBER
		A	AMS Specifications
DRAWN	3/27/2009		
CHECKED	PF 9/19/2013	REVISED	9/19/2013
		REV.	

THE INFORMATION CONTAINED IN THIS DRAWING IS THE SOLE PROPERTY OF BIO-MICROBICS INC. ANY REPRODUCTION IN PART OR AS A WHOLE WITHOUT THE WRITTEN PERMISSION OF BIO-MICROBICS INC. IS PROHIBITED. DESIGN AND INVENTION RIGHTS ARE RESERVED. IN THE INTEREST OF TECHNOLOGICAL ADVANCEMENT, ALL PRODUCTS ARE SUBJECT TO DESIGN AND OR MATERIAL CHANGE WITHOUT NOTICE.

BIO-MICROBICS © 2014

SHEET 8 OF 9

BIOSOLIDS MANAGEMENT SYSTEM (BMS) OPTION

1. GENERAL INSTALLATION INSTRUCTIONS

All work must be done in accordance with local codes and regulations. Installation of the BMS Option shall be done in accordance with the written instructions provided by the manufacturer. A manual which includes descriptions of system installation, operation, and maintenance procedures shall be furnished. For further details refer to the Installation Manual.

2. DECANT PUMP AND JIB CRANE

A decant pump is provided for pumping the supernatant from the BMS Zone to the MyFAST® Treatment Zone. The standard decant pump will be controlled by a manual start/stop controller. The jib crane is provided for adjusting the height of the decant pump. The jib crane is designed to handle a lifting capacity of 500 Lbs. and a lifting range of 160 inches [305cm]. All wiring must conform to all applicable codes (IEC, NEC, etc.). Wiring distances must prevent significant voltage loss.

PUMP DETAILS

- The standard 60 Hz decant pump shall be capable of pumping 100 to 125 gpm [380 to 470 Lpm] at 10 feet [3m] of total dynamic head. Input power on 60Hz electrical system is 3Ø, 208-230/460 VAC, and maximum 3.8/1.7 FLA. All conduit and wiring shall be supplied by others.
- The standard 50 Hz decant pump shall be capable of pumping 300 to 400 Lpm at 3m of total dynamic head. Input power on 50Hz electrical system is 3Ø, 380 VAC, and 1.5 FLA. All conduit and wiring shall be supplied by others.

3. LIXOR 6.0®

The LIXOR® 6.0 system shall provide oxygen and mixing to reduce biosolids quantity prior to final disposal. The contractor shall furnish and install (1) LIXOR® 6.0 aeration system in the BMS Zone of the MyFAST®. The system shall be complete with all needed equipment as shown on the drawings and specified herein. The principal items of equipment shall include LIXOR® aerator, blower assembly, blower controls and alarms. All other items will be provided by others. The LIXOR® 6.0 system shall be situated within the BMS Zone as shown on the plans and spaced for maximum mixing and aeration. The BMS Zone Tank(s) must provide adequate pump out access for wasting of solids, and must conform to local, state, and all other applicable codes.

- LIXOR® AERATOR**
The LIXOR® aerators shall be manufactured of rigid PVC and ABS. The aerator shall be fixed in position anchored by non corrosive fasteners supplied by others and contain no moving or wearing parts and shall not corrode.
- BLOWER**
The LIXOR® 6.0 system shall come equipped with a regenerative type blower capable of delivering 110-160 CFM [187-272 m³/hr]. The blower assembly shall include an inlet filter with metal filter element. The blower shall be secured on the walkway or perimeter of tank on a contractor supplied base. The blower must not set in standing water and its elevation must be higher than the normal flood level and the tank's operating level. A two-piece, blower housing shall be provided. The discharge air line from the blower to the LIXOR® unit shall be provided and installed by others.
- ELECTRICAL**
The electrical source should be within 150 feet [45.7 meters] of the blower consult local codes for longer wiring distances. All wiring must conform to all applicable codes (IEC, NEC, etc.). Wiring distances must prevent significant voltage loss. Input power on 60Hz electrical system is 3Ø, 208-230/460 VAC, and 21/9.5 FLA. Input power on 50Hz electrical system is 3Ø, 230/400 VAC, and 19.7/11.2 FLA. All conduit and wiring shall be supplied by others.
- CONTROLS**
The standard control panel provides power to the blower with an alarm system consisting of a visual and audible alarm capable of signaling blower circuit failure. The control panel is equipped with SFR® timed control feature. A manual silence button is included.
- VENTILATION**
If the BMS Zone is covered vent to the desired location and cover opening with a vent grate with at least 13 sq in. [80 sq. cm] open surface area. Secure with Stainless Steel screws. Vent piping must not allow condensate build up or create back pressure. Vent must be above finished grade or higher.

4. WARRANTY

Bio-Microbics, Inc. warrants all Bio-Microbics supplied BMS components against defects in materials and workmanship for a period of one year after installation or eighteen months from date of shipment which ever occurs first, subject to the following terms and conditions:

During the warranty period, if any part is defective or fails to perform as specified when operating at design conditions, and if the equipment has been installed and is being operated and maintained in accordance with the written instructions provided by Bio-Microbics, Inc., Bio-Microbics, Inc. will repair or replace at its discretion such defective parts free of charge. Defective parts must be returned by owner to Bio-Microbics, Inc.'s factory postage paid, if so requested. The cost of labor and all other expenses resulting from replacement of the defective parts and from installation of parts furnished under this warranty and regular maintenance items such as filters or bulbs shall be borne by the owner. This warranty does not cover: general system misuse, aerator components which have been damaged by flooding or any components that have been disassembled by unauthorized persons, improperly installed or damaged due to altered or improper wiring or overload protection. This warranty applies only to the BMS components and does not include any of the structure wiring, plumbing, drainage, septic tank or disposal system.

Bio-Microbics, Inc. reserves the right to revise, change or modify the construction and/or design of the components, without incurring any obligation to make such changes or modifications in present equipment. Bio-Microbics, Inc. is not responsible for consequential or incidental damages of any nature resulting from such things as, but not limited to, defect in design, material, or workmanship, or delays in delivery, replacements or repairs. THIS WARRANTY IS IN LIEU OF ALL OTHER WARRANTIES EXPRESS OR IMPLIED. BIO-MICROBICS SPECIFICALLY DISCLAIMS ANY IMPLIED WARRANTY OF MERCHANTABILITY OR FITNESS FOR A PARTICULAR PURPOSE. NO REPRESENTATIVE OR PERSON IS AUTHORIZED TO GIVE ANY OTHER WARRANTY OR TO ASSUME FOR BIO-MICROBICS, INC., ANY OTHER LIABILITY IN CONNECTION WITH THE SALE OF ITS PRODUCTS. Contact your local distributor for parts and service.

DO NOT SCALE		 BETTER WATER. BETTER WORLD.® MyFAST 12.0	
UNLESS NOTED DIMENSIONS ARE IN INCHES [CENTIMETERS] TOLERANCES ± 0.02 IN/IN [± 0.05 CM/CM]			
WEIGHT	lb	SIZE	DRAWING NUMBER
		A	BMS Specifications
DRAWN	3/27/2009	CHECKED	PF 9/19/2013
REVISED 9/19/2013		REV.	

THE INFORMATION CONTAINED IN THIS DRAWING IS THE SOLE PROPERTY OF BIO-MICROBICS INC. ANY REPRODUCTION IN PART OR AS A WHOLE WITHOUT THE WRITTEN PERMISSION OF BIO-MICROBICS INC. IS PROHIBITED. DESIGN AND INVENTION RIGHTS ARE RESERVED. IN THE INTEREST OF TECHNOLOGICAL ADVANCEMENT, ALL PRODUCTS ARE SUBJECT TO DESIGN AND OR MATERIAL CHANGE WITHOUT NOTICE.

BIO-MICROBICS © 2014

SHEET 9 OF 9